

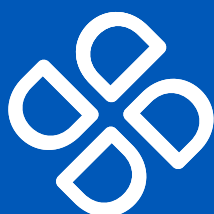

MITSUBISHI ELECTRIC

K L I M A U R E Đ A J I

KATALOG KUĆNE SERIJE



DELTRON®

Život ispunjen opuštajućom klimom.

'22./'23.



K L I M A U R E Đ A J I

Činiš se

kao netko tko čuva naš planet.

Jedini je kojeg imamo.

Činiš se kao netko tko je izabrao **Mitsubishi Electric.**



Mitsubishi Electric, uživanje u idealnoj klimi.





MSZ-RW

- 3D I-See senzor
- Plasma Quad Plus filter
- Econo Cool funkcija
- Tjedni tajmer
- Samodijagnoza
- Automatsko prebacivanje načina rada
- Samodijagnoza
- Dvostruki premaz
- I-Save način rada
- Automatska dvostruka krilca
- Noćni način rada

A+++
R32

-30°C ~ 24°C
-10°C ~ 46°C

**Mitsubishi Electric izumio je ultra-
učinkovito rješenje za "posebno grijanje".**

Njegove glavne prednosti? Jamstvo kvalitetnog grijanja čak i u ekstremnim uvjetima **do -30°C** i održavanjem snage grijanja od +7°C do -25°C. Uz Hyper Heating Ultimate tehnologiju otkrit ćete neusporedivu učinkovitost grijanja.

NOVO!

MODEL	UČINAK (W)		SEER / SCOP ENER. KLASA	DIMENZIJE v / š / d (mm)
	HLABENJE	GRIJANJE		
MSZ-RW25VG	2500	3200	11,2 / 5,2	305 / 998 / 247
MUZ-RW25VGHZ	(900-3500)	(800-6300)	(A+++ / A+++)	714 / 800 / 285
MSZ-RW35VG	3500	4000	9,4 / 5,1	305 / 998 / 247
MUZ-RW35VGHZ	(1000-4000)	(1100-7000)	(A+++ / A+++)	714 / 800 / 285
MSZ-RW50VG	5000	6000	7,6 / 4,6	305 / 998 / 247
MUZ-RW50VGHZ	(1400-5800)	(1800-8700)	(A++ / A++)	880 / 840 / 330

CJEVOVOD	UČINAK (kW)		
	2,5	3,5	5,0
Max. visinska razlika [m]	12	12	15
Max. duljina instalacije [m]	20	20	30
Promjer cijevi tekuće faze [mm]	6,35	6,35	6,35
Promjer cijevi plinovite faze [mm]	9,52	9,52	9,52



MSZ-DW

A++
R32

- V Blocking filter
- Econo Cool funkcija
- Automatsko prebacivanje načina rada
- Samodijagnoza
- Automatsko zakretanje krilaca
- Filter za pročišćavanje zraka

-10°C ~ 24°C
-10°C ~ 46°C
NOVO!

MODEL	UČINAK (W)		SEER / SCOP ENER. KLASA	DIMENZIJE V / Š / D (mm)
	HLADENJE	GRIJANJE		
MSZ-DW25VF	2500	3150	6,2 / 4,3	290 / 799 / 232
MUZ-DW25VF	(500-2900)	(700-3500)	(A++/A+)	538 / 699 / 249
MSZ-DW35VF	3400	3600	6,2 / 4,3	290 / 799 / 232
MUZ-DW35VF	(900-3400)	(900-3700)	(A++/A+)	538 / 699 / 249
MSZ-DW50VF	5000	5400	6,5 / 4,3	290 / 799 / 232
MUZ-DW50VF	(1300-5000)	(1400-6500)	(A++/A+)	550 / 800 / 285

CJEVOVOD	UČINAK (kW)		
	2,5	3,4	5,0
Max. visinska razlika [m]	12	12	15
Max. duljina instalacije [m]	20	20	20
Promjer cijevi tekuće faze [mm]	6,35	6,35	6,35
Promjer cijevi plinovite faze [mm]	9,52	9,52	9,52

MSZ-LN

KIRIGAMINE STYLE

STANDARDNO UKLJUČENO

- 3D I-See senzor
- Area funkcija
- Prepoznavanje korisnika
- Econo-cool funkcija
- Automatska dvostruka krilca
- Tjedni tajmer
- Samodijagnoza
- Replace Tehnologija
- Automatsko prebacivanje načina rada
- Dvostruki premaz
- I-Save način rada
- Plasma Quad plus funkcija
- Noćni način rada

CRVENI
BISERNO BIJELI

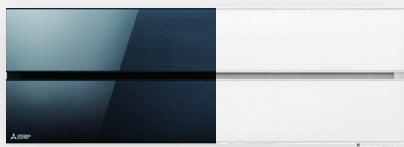
CRNI
BIJELI

MODEL	UČINAK (W)		SEER / SCOP ENER. KLASA	DIMENZIJE V / S / D (mm)
	HLADNJE	GRIJANJE		
CRVENI MODELI				
MSZ-LN25VGR	2500	3200	10,5 / 5,2	307 / 890 / 233
MUZ-LN25VG	(1000-3500)	(800-5400)	(A+++ / A+++)	550 / 800 / 285
MSZ-LN35VGR	3500	4000	9,5 / 5,1	307 / 890 / 233
MUZ-LN35VG	(800-4000)	(1000-6300)	(A+++ / A+++)	550 / 800 / 285
MSZ-LN50VGR	5000	6000	8,5 / 4,6	307 / 890 / 233
MUZ-LN50VG	(1000-6000)	(1000-8200)	(A+++ / A++)	714 / 800 / 285
MSZ-LN60VGR	6100	6800	7,5 / 4,6	307 / 890 / 233
MUZ-LN60VG	(1400-6900)	(1800-9300)	(A++ / A++)	880 / 840 / 330
BISERNO BIJELI MODELI				
MSZ-LN25VGV	2500	3200	10,5 / 5,2	307 / 890 / 233
MUZ-LN25VG	(1000-3500)	(800-5400)	(A+++ / A+++)	550 / 800 / 285
MSZ-LN35VGV	3500	4000	9,5 / 5,1	307 / 890 / 233
MUZ-LN35VG	(800-4000)	(1000-6300)	(A+++ / A+++)	550 / 800 / 285
MSZ-LN50VGV	5000	6000	8,5 / 4,6	307 / 890 / 233
MUZ-LN50VG	(1000-6000)	(1000-8200)	(A+++ / A++)	714 / 800 / 285
MSZ-LN60VGV	6100	6800	7,5 / 4,6	307 / 890 / 233
MUZ-LN60VG	(1400-6900)	(1800-9300)	(A++ / A++)	880 / 840 / 330
CRNI MODELI				
MSZ-LN25VGB	2500	3200	10,5 / 5,2	307 / 890 / 233
MUZ-LN25VG	(1000-3500)	(800-5400)	(A+++ / A+++)	550 / 800 / 285
MSZ-LN35VGB	3500	4000	9,5 / 5,1	307 / 890 / 233
MUZ-LN35VG	(800-4000)	(1000-6300)	(A+++ / A+++)	550 / 800 / 285
MSZ-LN50VGB	5000	6000	8,5 / 4,6	307 / 890 / 233
MUZ-LN50VG	(1000-6000)	(1000-8200)	(A+++ / A++)	714 / 800 / 285
MSZ-LN60VGB	6100	6800	7,5 / 4,6	307 / 890 / 233
MUZ-LN60VG	(1400-6900)	(1800-9300)	(A+++ / A++)	880 / 840 / 330
BIJELI MODELI				
MSZ-LN25VGW	2500	3200	10,5 / 5,2	307 / 890 / 233
MUZ-LN25VG	(1000-3500)	(800-5400)	(A+++ / A+++)	550 / 800 / 285
MSZ-LN35VGW	3500	4000	9,5 / 5,1	307 / 890 / 233
MUZ-LN35VG	(800-4000)	(1000-6300)	(A+++ / A+++)	550 / 800 / 285
MSZ-LN50VGW	5000	6000	8,5 / 4,6	307 / 890 / 233
MUZ-LN50VG	(1000-6000)	(1000-8200)	(A+++ / A++)	714 / 800 / 285
MSZ-LN60VGW	6100	6800	7,5 / 4,6	307 / 890 / 233
MUZ-LN60VG	(1400-6900)	(1800-9300)	(A++ / A++)	880 / 840 / 330

R32

-15°C ~ 24°C
-10°C ~ 46°C

CJEVOVOD	SNAGA (kW)			
	2,5	3,5	5,0	6,1
Max. visinska razlika [m]	12	12	12	15
Max. dužina instalacije [m]	20	20	30	30
Promjer cijevi tekuće faze [mm]	6,35	6,35	6,35	6,35
Promjer cijevi plinovite faze [mm]	9,52	9,52	9,52	12,7

MODEL	UČINAK (W)		SEER / SCOP ENER. KLASA	DIMENZIJE V / Š / D (mm)
	HLADENJE	GRIJANJE		
SREBRNI MODELI				
MSZ-EF25VES	2500	3200	9,1/4,7	299 / 895 / 195
MUZ-EF25VG	(900-3400)	(1000-4200)	(A+++/A++)	550 / 800 / 285
MSZ-EF35VES	3500	4000	8,8/4,6	299 / 895 / 195
MUZ-EF35VG	(1100-4000)	(1300-5100)	(A+++/A++)	550 / 800 / 285
MSZ-EF42VES	4200	5400	7,9/4,6	299 / 895 / 195
MUZ-EF42VG	(900-4600)	(1300-6300)	(A++/A++)	550 / 800 / 285
MSZ-EF50VES	5000	5800	7,5/4,5	299 / 895 / 195
MUZ-EF50VG	(1400-5400)	(1400-7500)	(A++/A+)	714 / 800 / 285
CRNI MODELI				
MSZ-EF25VEB	2500	3200	9,1/4,7	299 / 895 / 195
MUZ-EF25VGB	(900-3400)	(1000-4200)	(A+++/A++)	550 / 800 / 285
MSZ-EF35VEB	3500	4000	8,8/4,6	299 / 895 / 195
MUZ-EF35VGB	(1100-4000)	(1300-5100)	(A+++/A++)	550 / 800 / 285
MSZ-EF42VEB	4200	5400	7,9/4,6	299 / 895 / 195
MUZ-EF42VGB	(900-4600)	(1300-6300)	(A++/A++)	550 / 800 / 285
MSZ-EF50VEB	5000	5800	7,5/4,5	299 / 895 / 195
MUZ-EF50VGB	(1400-5400)	(1400-7500)	(A++/A+)	714 / 800 / 285
BIJELI MODELI				
MSZ-EF25VEW	2500	3200	9,1/4,7	299 / 895 / 195
MUZ-EF25VGW	(900-3400)	(1000-4200)	(A+++/A++)	550 / 800 / 285
MSZ-EF35VEW	3500	4000	8,8/4,6	299 / 895 / 195
MUZ-EF35VGW	(1100-4000)	(1300-5100)	(A+++/A++)	550 / 800 / 285
MSZ-EF42VEW	4200	5400	7,9/4,6	299 / 895 / 195
MUZ-EF42VGW	(900-4600)	(1300-6300)	(A++/A++)	550 / 800 / 285
MSZ-EF50VEW	5000	5800	7,5/4,5	299 / 895 / 195
MUZ-EF50VGW	(1400-5400)	(1400-7500)	(A++/A+)	714 / 800 / 285

CJEVOVOD	SNAGA (kW)			
	2,5	3,5	4,2	5,0
Max. visinska razlika [m]	12	12	12	15
Max. dužina instalacije [m]	20	20	20	30
Promjer cijevi tekuće faze [mm]	6,35	6,35	6,35	6,35
Promjer cijevi plinovite faze [mm]	9,52	9,52	9,52	9,52



-15°C ~ 24°C
-10°C ~ 46°C

MSZ-EF KIRIGAMINE ZEN

STANDARDNO UKLJUČENO

- Econo-cool funkcija
- Automatsko zakretanje lopatica
- Automatska brzina ventilatora
- Automatsko prebacivanje načina rada
- Silver-ion filter
- Filter za pročišćavanje zraka
- Tjedni tajmer
- Samodijagnoza
- Hlađenje pri niskim temperaturama
- I-Save funkcija



MSZ-AP

STANDARDNO UKLJUČENO

- Tihi rad s niskom razinom buke
- Automatska dvostruka krilca
- Tjedni tajmer
- Samodijagnoza
- Replace Tehnologija
- Automatsko prebacivanje načina rada
- I-Save način rada

MODEL	UČINAK (W)		SEER / SCOP ENER. KLASA	DIMENZIJE V / Š / D (mm)
	HLADENJE	GRIJANJE		
MSZ-AP20VG MUZ-AP20VG	2000 (600-2700)	2500 (500-3500)	8,6/4,2 (A+++ / A+)	250 / 760 / 178 550 / 800 / 285
MSZ-AP25VG MUZ-AP25VG	2500 (900-3400)	3200 (1000-4100)	8,6 / 4,8 (A+++ / A++)	299 / 798 / 219 550 / 800 / 285
MSZ-AP35VG MUZ-AP35VG	3500 (1100-3800)	4000 (1300-4600)	8,6 / 4,7 (A+++ / A++)	299 / 798 / 219 550 / 800 / 285
MSZ-AP42VG MUZ-AP42VG	4200 (900-4500)	5400 (1300-6000)	7,8 / 4,7 (A++ / A++)	299 / 798 / 219 550 / 800 / 285
MSZ-AP50VG MUZ-AP50VG	5000 (1400-5400)	5800 (1400-7300)	7,4 / 4,7 (A++ / A++)	299 / 798 / 219 714 / 800 / 285
MSZ-AP60VG MUZ-AP60VG	6100 (1400-7300)	6800 (2000-8600)	7,4 / 4,6 (A++ / A++)	325 / 1100 / 257 714 / 800 / 285
MSZ-AP71VG MUZ-AP71VG	7100 (2000-8700)	8100 (2200-10300)	7,2 / 4,4 (A++ / A+)	325 / 1100 / 257 800 / 840 / 330

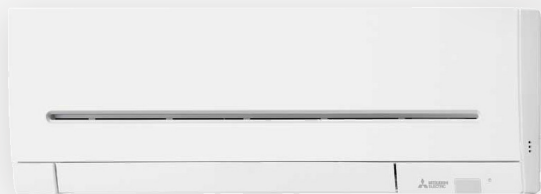

-15°C ~ 24°C
-10°C ~ 46°C

CJEVOVOD	SNAGA (kW)						
	2,0	2,5	3,5	4,2	5,0	6,0	7,1
Max. visinska razlika [m]	12	12	12	12	12	15	15
Max. dužina instalacije [m]	20	20	20	20	20	30	30
Promjer cijevi tekuće faze [mm]	6,35	6,35	6,35	6,35	6,35	6,35	6,35
Promjer cijevi plinovite faze [mm]	9,52	9,52	9,52	9,52	9,52	12,7	12,7

MODEL	UČINAK (W)		SEER / SCOP ENER. KLASA	DIMENZIJE V / Š / D (mm)
	HLADENJE	GRIJANJE		
MSZ-BT20VG MUZ-BT20VG	2000 (500 - 2900)	2500 (700 - 3200)	8,1/4,3 (A++/A+)	280 / 838 / 235 538 / 699 / 249
MSZ-BT25VG MUZ-BT25VG	2500 (500 - 3000)	3150 (700 - 3500)	8,1/4,6 (A++/A++)	280 / 838 / 235 538 / 699 / 249
MSZ-BT35VG MUZ-BT35VG	3500 (900 - 3500)	3600 (900 - 4100)	6,8/4,6 (A++/A++)	280 / 838 / 235 538 / 699 / 249
MSZ-BT50VG MUZ-BT50VG	5000 (1300 - 5000)	5400 (1400 - 6500)	6,6/4,4 (A++/A+)	280 / 838 / 235 550 / 800 / 285

CJEVOVOD	SNAGA (kW)			
	2,0	2,5	3,5	5,0
Max. visinska razlika [m]	12	12	12	12
Max. dužina instalacije [m]	20	20	20	20
Promjer cijevi tekuće faze [mm]	6,35	6,35	6,35	6,35
Promjer cijevi plinovite faze [mm]	9,52	9,52	9,52	12,7



-15°C ~ 24°C
-10°C ~ 46°C

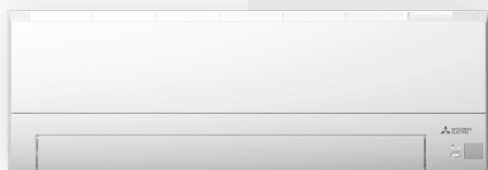

MSZ-BT

STANDARDNO UKLJUČENO

- Automatsko zakretanje krilaca
- Tihi rad s niskom razinom buke
- Filter za pročišćavanje zraka
- Econo Cool funkcija
- Samodijagnoza
- Auto restart
- Tajmer
- Automatski rad

MSZ-GF

STANDARDNO UKLJUČENO

- Automatsko zakretanje lopatica
- Vertikalni položaj krilaca
- Automatsko prebacivanje načina rada
- Filter za pročišćavanje zraka
- Samodijagnoza
- Tjedni tajmer
- I-Save način rada

MODEL	UČINAK (W)		SEER / SCOP ENER. KLASA	DIMENZIJE V / Š / D (mm)
	HLADENJE	GRIJANJE		
MSZ-GF60VE MUZ-GF60VE	6100 (1400-7500)	6800 (2000-9300)	6,8 / 4,3 (A++ / A+)	325 / 1100 / 238 880 / 840 / 330
MSZ-GF71VE MUZ-GF71VE	7100 (2000-8700)	8100 (2200-9900)	6,8 / 4,2 (A++ / A+)	325 / 1100 / 238 880 / 840 / 330

Dostupnost do isteka zaliha.

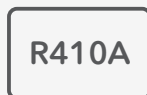

-15°C ~ 24°C
-10°C ~ 46°C

CJEVOVOD	SNAGA (kW)	
	6,1	7,1
Max. visinska razlika [m]	15	15
Max. dužina instalacije [m]	30	30
Promjer cijevi tekuće faze [mm]	6,35	9,52
Promjer cijevi plinovite faze [mm]	15,88	15,88



MSZ-HR

STANDARDNO UKLJUČENO

- Poboljšana učinkovitost
- Tihi rad s niskom razinom buke
- Econo Cool funkcija
- Samodijagnoza
- Automatsko prebacivanje načina rada



MODEL	UČINAK (W)		SEER / SCOP ENER. KLASA	DIMENZIJE V / Š / D (mm)
	HLADENJE	GRIJANJE		
MSZ-HR25VF MUZ-HR25VF	2500 (500-2900)	3150 (700-3500)	6,2 / 4,3 (A++ / A+)	280 / 838 / 228 538 / 699 / 249
MSZ-HR35VF MUZ-HR35VF	3400 (900-3400)	3600 (900-3700)	6,2 / 4,3 (A++ / A+)	280 / 838 / 228 538 / 699 / 249
MSZ-HR42VF MUZ-HR42VF	4200 (1100-4500)	4700 (900-5400)	6,5 / 4,3 (A++ / A+)	280 / 838 / 228 550 / 800 / 285
MSZ-HR50VF MUZ-HR50VF	5000 (1300-5000)	5400 (1400-6500)	6,5 / 4,3 (A++ / A+)	280 / 838 / 228 550 / 800 / 285
MSZ-HR60VF MUZ-HR60VF	6100 (1700-7400)	6800 (1500-9000)	7,2/4,5 (A++/A+)	305 / 923 / 262 714 / 800 / 285
MSZ-HR71VF MUZ-HR71VF	7100 (1800-7400)	8100 (1500-9000)	7,0/4,3 (A++/A+)	305 / 923 / 262 714 / 800 / 285



CJEVOVOD	SNAGA (kW)					
	2,5	3,4	4,2	5,0	6,1	7,1
Max. visinska razlika [m]	12	12	12	12	15	15
Max. dužina instalacije [m]	20	20	20	20	30	30
Promjer cijevi tekuće faze [mm]	6,35	6,35	6,35	6,35	6,35	6,35
Promjer cijevi plinovite faze [mm]	9,52	9,52	9,52	9,52	12,7	12,7

MODEL	UČINAK (W)		SEER / SCOP ENER. KLASA	DIMENZIJE V / Š / D (mm)
	HLADENJE	GRIJANJE		
MSZ-HJ60VA MUZ-HJ60VA	6100 (1700-7100)	6800 (1500-8400)	6,0 / 4,1 (A+ / A+)	305 / 923 / 250 880 / 840 / 330
MSZ-HJ71VA MUZ-HJ71VA	7100 (1800-7100)	8100 (1500-8500)	5,6 / 4,0 (A+ / A+)	305 / 923 / 250 880 / 840 / 330

CJEVOVOD	SNAGA (kW)				
	2,5	3,15	5,0	6,1	7,1
Max. visinska razlika [m]	12	12	12	15	15
Max. dužina instalacije [m]	20	20	20	30	30
Promjer cijevi tekuće faze [mm]	6,35	6,35	6,35	6,35	9,52
Promjer cijevi plinovite faze [mm]	9,52	9,52	12,7	15,88	15,88

Dostupnost do isteka zaliha.

MSZ-HJ

STANDARDNO UKLJUČENO

- Automatska brzina ventilatora
- Automatsko zakretanje lopatica
- Samodijagnoza
- Econo Cool funkcija
- Auto restart

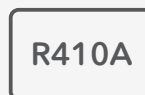

PODNA IZVEDBA

DC INVERTER SERIJA

MFZ-KT

STANDARDNO UKLJUČENO

- Econo-cool funkcija
- Automatsko zakretanje lopatica
- Automatska brzina ventilatora
- Tjedni tajmer
- I-Save funkcija
- Silver-ion
- Filter za pročišćavanje zraka
- Automatsko prebacivanje načina rada

MODEL	UČINAK (W)		SEER / SCOP ENER. KLASA	DIMENZIJE V / Š / D (mm)
	HLADENJE	GRIJANJE		
MFZ-KT25VG SUZ-M25VA	2500 (1600 - 3200)	3400 (1300-4200)	6,5/4,2 (A++/A+)	600 / 750 / 215 550 / 800 / 285
MFZ-KT35VG SUZ-M35VA	3500 (900-3900)	4300 (1100-5000)	6,6/4,4 (A++/A+)	600 / 750 / 215 550 / 800 / 285
MFZ-KT50VG SUZ-M50VA	5000 (1200-5600)	6000 (1500-7200)	6,8/4,2 (A++/A+)	600 / 750 / 215 714 / 800 / 285
MFZ-KT60VG SUZ-M60VA	6100 (1700-6300)	7000 (1600-8000)	6,2/4,1 (A++/A+)	600 / 750 / 215 880 / 840 / 330

CJEVOVOD	SNAGA (kW)			
	2,5	3,5	5,0	6,1
Max. visinska razlika [m]	12	12	30	30
Max. dužina instalacije [m]	20	20	30	30
Promjer cijevi tekuće faze [mm]	6,35	6,35	6,35	6,35
Promjer cijevi plinovite faze [mm]	9,52	9,52	12,7	15,8



M25, M35

 -10°C ~ 24°C
-10°C ~ 46°C

M50, M60

 -10°C ~ 24°C
-15°C ~ 46°C

KAZETNA IZVEDBA

1-SMJERNA - DC INVERTER SERIJA

MLZ-KP

STANDARDNO UKLJUČENO

- Automatsko zakretanje lopatica
- Dovod svježeg zraka
- Signal za provjeru filtera
- Dugotrajni filter
- Automatsko prebacivanje načina rada
- Auto restart
- Hlađenje pri niskim temperaturama
- 24 satni tajmer
- Samodijagnoza
- Horizontalni položaj krilaca

M25, M35

 -10°C ~ 24°C
-10°C ~ 46°C

M50

 -10°C ~ 24°C
-15°C ~ 46°C

MODEL	UČINAK (W)		SEER / SCOP ENER. KLASA	DIMENZIJE V / Š / D (mm)
	HLADENJE	GRIJANJE		
Bežični daljinski upravljač i maska MLP-444W uključeni u cijenu.				
MLZ-KP25VF				185 / 1102 / 360
MLP-444W	2500 (1400-3200)	3200 (1400-4200)	6,2 / 4,4 (A++ / A+)	24 / 1200 / 424
SUZ-M25VA				550 / 800 / 285
MLZ-KP35VF				185 / 1102 / 360
MLP-444W	3500 (800-3900)	4100 (1100-4900)	7,0 / 4,6 (A++ / A++)	24 / 1200 / 424
SUZ-M35VA				550 / 800 / 285
MLZ-KP50VF				185 / 1102 / 360
MLP-444W	5000 (1700-5600)	6000 (1700-7200)	6,7 / 4,3 (A++ / A+)	24 / 1200 / 424
SUZ-M50VA				714 / 800 / 285

CJEVOVOD	SNAGA (kW)		
	2,5	3,5	5,0
Max. visinska razlika [m]	12	12	30
Max. dužina instalacije [m]	20	20	30
Promjer cijevi tekuće faze [mm]	6,35	6,35	6,35
Promjer cijevi plinovite faze [mm]	9,52	9,52	12,7



KAZETNA IZVEDBA

4-SMJERNA - DC INVERTER SERIJA

SLZ-M

STANDARDNO UKLJUČENO

- Automatsko zakretanje lopatica
- Dovod svježeg zraka
- Signal za provjeru filtera
- Dugotrajni filter
- Automatsko prebacivanje načina rada
- Auto restart
- Hlađenje pri niskim temperaturama
- 24 satni tajmer
- Samodijagnoza
- Vertikalni položaj krilaca



M25, M35



M50, M60



MODEL	UČINAK (W)		SEER / SCOP ENER. KLASA	DIMENZIJE V / Š / D (mm)
	HLADENJE	GRIJANJE		
Žičani daljinski upravljač PAR-40MAA i ukrasna maska SLP-2FA uključeni u cijenu.				
SLZ-M25FA				245 / 570 / 570
PAR-40MAA	2500	3200	6,3 / 4,3	120 / 120 / 19
SLP-2FAL	(1400-3200)	(1300-4200)	(A++ / A+)	10 / 625 / 625
SUZ-M25VA				550 / 800 / 285
SLZ-M35FA				245 / 570 / 570
PAR-40MAA	3500	4000	6,7 / 4,3	120 / 120 / 19
SLP-2FAL	(700-3900)	(1000-5000)	(A++ / A+)	10 / 625 / 625
SUZ-M35VA				550 / 800 / 285
SLZ-M50FA				245 / 570 / 570
PAR-40MAA	4600	5000	6,3 / 4,2	120 / 120 / 19
SLP-2FAL	(1000-5200)	(1300-5500)	(A++ / A+)	10 / 625 / 625
SUZ-M50VA				714 / 800 / 285
SLZ-M60FA				245 / 570 / 570
PAR-40MAA	5700	6400	6,2 / 4,1	120 / 120 / 19
SLP-2FAL	(1500-6300)	(1600-7300)	(A++ / A+)	10 / 625 / 625
SUZ-M60VA				880 / 840 / 330
Bežični daljinski upravljač i maska SLP-2FALM uključeni u cijenu.				
SLZ-M25FA				245 / 570 / 570
SLP-2FALM	2500	3200	6,3 / 4,3	10 / 625 / 625
SUZ-M25VA				550 / 800 / 285
SLZ-M35FA				245 / 570 / 570
SLP-2FALM	3500	4000	6,7 / 4,3	10 / 625 / 625
SUZ-M35VA				550 / 800 / 285
SLZ-M50FA				245 / 570 / 570
SLP-2FALM	4600	5000	6,3 / 4,2	10 / 625 / 625
SUZ-M50VA				714 / 800 / 285
SLZ-M60FA				245 / 570 / 570
SLP-2FALM	5700	6400	6,2 / 4,1	10 / 625 / 625
SUZ-M60VA				880 / 840 / 330

CJEVOVOD	SNAGA (kW)			
	2,5	3,5	4,6	5,7
Max. visinska razlika [m]	12	12	30	30
Max. dužina instalacije [m]	20	20	30	30
Promjer cijevi tekuće faze [mm]	6,35	6,35	6,35	6,35
Promjer cijevi plinovite faze [mm]	9,52	9,52	12,7	15,88

KANALSKA IZVEDBA

DC INVERTER SERIJA

MODEL	UČINAK (W)		SEER / SCOP ENER. KLASA	DIMENZIJE V / Š / D (mm)
	HLADENJE	GRIJANJE		
SEZ-M25DA SUZ-M25VA PAR-40MAA	2500 (1500-3200)	2900 (1300-4500)	5,3 / 3,8 (A / A)	200 / 790 / 700 550 / 800 / 285
SEZ-M35DA SUZ-M35VA PAR-40MAA	3500 (1400-3900)	4200 (1700-5000)	5,7 / 4,0 (A+ / A+)	200 / 990 / 700 550 / 800 / 285
SEZ-M50DA SUZ-M50VA PAR-40MAA	5100 (2300-5600)	6400 (1700-7200)	5,8 / 3,9 (A+ / A)	200 / 990 / 700 880 / 840 / 330
SEZ-M60DA SUZ-M60VA PAR-40MAA	5600 (2300-6300)	7400 (2500-8000)	5,3 / 4,1 (A / A+)	200 / 1190 / 700 880 / 840 / 330
SEZ-M71DA SUZ-M71VA PAR-40MAA	7100 (2800-8300)	8100 (2600-10400)	5,3 / 3,8 (A / A)	200 / 1190 / 700 880 / 840 / 330

SEZ-M

STANDARDNO UKLJUČENO

- Automatsko prebacivanje načina rada
- Automatsko zakretanje lopatica
- Auto restart
- Hlađenje pri niskim temperaturama
- 24 satni tajmer
- Samodijagnoza

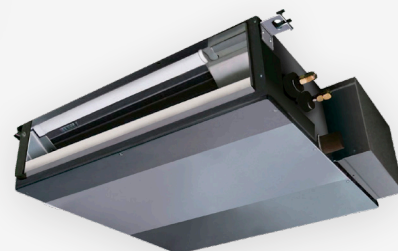

CJEVOVOD	SNAGA (kW)				
	2,5	3,5	5,1	5,6	7,1
Max. visinska razlika [m]	12	12	30	30	30
Max. dužina instalacije [m]	20	20	30	30	30
Promjer cijevi tekuće faze [mm]	6,35	6,35	6,35	6,35	9,52
Promjer cijevi plinovite faze [mm]	9,52	9,52	12,7	15,88	15,88



MULTI SUSTAVI STANDARD DC INVERTER SERIJA

MODEL	MEDIJ	UČINAK (W)		SEER / SCOP ENER. KLASA	DIMENZIJE V / Š / D (mm)
		HLADENJE	GRIJANJE		
MXZ-2DM40VA	R410A	4000 (1100-4300)	4300 (1000-4800)	6,1 / 4,0 (A++ / A+)	550 / 800 / 285
MXZ-2HA40VF	R32	4000 (1100-4300)	4300 (1000-4800)	8,12 / 4,3 (A++ / A+)	550 / 800 / 285
MXZ-2HA50VF	R32	5000 (1100-5400)	6000 (1000-6400)	7,78 / 4,3 (A++ / A+)	550 / 800 / 285



MOGUĆNOST SPAJANJA DO 2
UNUTARNJE JEDINICE

MODEL	MEDIJ	UČINAK (W)		SEER / SCOP ENER. KLASA	DIMENZIJE V / Š / D (mm)
		HLADENJE	GRIJANJE		
MXZ-3DM50VA	R410A	5000 (2700-6500)	6000 (2400-7500)	6,1 / 3,8 (A++ / A)	710 / 840 / 330
MXZ-3HA50VF	R32	5000 (2900-6500)	6000 (2600-7500)	7,26 / 4,02 (A++ / A+)	710 / 840 / 330



MOGUĆNOST SPAJANJA DO 3
UNUTARNJE JEDINICE

VANJSKE JEDINICE

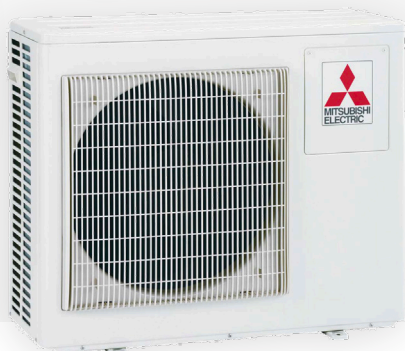
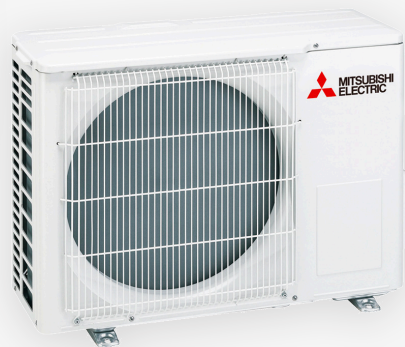

ODGOVARAJUĆA UNUTARNJA JEDINICA



MODEL	DIMENZIJE V / Š / D (mm)
Za vanjske jedinice MXZ-2DM / MXZ-3DM	
MSZ-HJ25VA	290 / 799 / 232
MSZ-HJ35VA	290 / 799 / 232
MSZ-HJ50VA	290 / 799 / 232
Za vanjske jedinice MXZ-2HA / MXZ-3HA	
MSZ-HR25VF	280 / 838 / 228
MSZ-HR35VF	280 / 838 / 228
MSZ-HR42VF	280 / 838 / 228
MSZ-HR50VF	280 / 838 / 228

MULTI SUSTAVI

POWER DC INVERTER SERIJA

VANJSKE JEDINICE

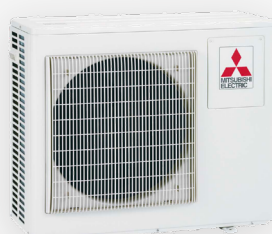

MODEL	MEDIJ	UČINAK (W)		EER / COP ENER. KLASA	DIMENZIJE V / Š / D (mm)
		HLADENJE	GRIJANJE		
MXZ-2F33VF	R32	3300 (1100-3800)	4000 (1000-4100)	6,13 / 4,16 (A++ / A+)	550 / 800 / 285
MXZ-2F42VF	R32	4200 (1100-4400)	4500 (1000-4800)	8,69 / 4,60 (A+++ / A++)	550 / 800 / 285
MXZ-2F53VF	R32	5300 (1100-5600)	6400 (1000-7000)	8,63 / 4,60 (A+++ / A++)	550 / 800 / 285

MOGUĆNOST SPAJANJA DO 2 UNUTARNJE JEDINICE



MODEL	MEDIJ	UČINAK (W)		EER / COP ENER. KLASA	DIMENZIJE V / Š / D (mm)
		HLADENJE	GRIJANJE		
MXZ-3F54VF	R32	5400 (2900-6800)	7000 (2600-9000)	8,52 / 4,61 (A+++ / A++)	710 / 840 / 330
MXZ-3F68VF	R32	6800 (2900-8400)	8600 (2600-10600)	7,96 / 4,12 (A++ / A+)	710 / 840 / 330

MOGUĆNOST SPAJANJA DO 3 UNUTARNJE JEDINICE



MODEL	MEDIJ	UČINAK (W)		EER / COP ENER. KLASA	DIMENZIJE V / Š / D (mm)
		HLADENJE	GRIJANJE		
MXZ-4F72VF	R32	7200 (3700-8800)	8600 (3400-10700)	8,13 / 4,07 (A++ / A+)	710 / 840 / 330
MXZ-4F80VF	R32	8000 (3700 - 9000)	8800 (3400 - 11000)	7,6 / 4,1 (A+++ / A++)	710 / 840 / 330
MXZ-4F83VF	R32	8300 (3700-9200)	9300 (3400-11600)	8,5 / 4,7 (A+++ / A++)	796 / 950 / 330

MOGUĆNOST SPAJANJA DO 4 UNUTARNJE JEDINICE



MODEL	MEDIJ	UČINAK (W)		EER / COP ENER. KLASA	DIMENZIJE V / Š / D (mm)
		HLADENJE	GRIJANJE		
MXZ-5F102VF	R32	10200 (3900-11000)	10500 (4100-14000)	8,2 / 4,7 (A++ / A++)	796 / 950 / 330

MOGUĆNOST SPAJANJA DO 5 UNUTARNJIH JEDINICA



MODEL	MEDIJ	UČINAK (W)		EER / COP ENER. KLASA	DIMENZIJE V / Š / D (mm)
		HLADENJE	GRIJANJE		
MXZ-6F122VF	R32	12200 (3500-14000)	14000 (3500-16500)	3,33 / 4,23 (A / A)	1048 / 950 / 330

MOGUĆNOST SPAJANJA DO 6 UNUTARNJIH JEDINICA



CJEVOVOD	SNAGA (kW)									
	3,3	4,2	5,3	5,4	6,8	7,2	8,3	10,2	12,2	
Max. visinska razlika [m]	10	15(10)*	15(10)*	15(10)*	15(10)*	15(10)*	15	15	15	
Max. dužina instalacije [m] (ukupno/pojedinačno)	20 / 15	30 / 20	30 / 20	50 / 25	60 / 25	60 / 25	70 / 25	80 / 25	80 / 25	

* Ako je vanjska jedinica iznad unutarnje jedinice, maksimalna visinska razlika iznosi 10m.



MODEL	MEDIJ	UČINAK (W)		EER / COP ENER. KLASA	NAPAJANJE (FAZA-NAPON-FREKVENCIJA)
		HLADENJE	GRIJANJE		
PUMY-SP112VK	R410A	12500	14000	4,03 / 4,42 (A / A)	Monofazno 1Ph - 230V - 50Hz
PUMY-SP125VK	R410A	14000	16000	3,65 / 4,10 (A / A)	
PUMY-SP140VK	R410A	15500	16500	3,30 / 4,10 (A / A)	
PUMY-SP112YK	R410A	12500	14000	4,03 / 4,42 (A / A)	Trofazno 3Ph - 400V - 50Hz
PUMY-SP125YK	R410A	14000	16000	3,65 / 4,10 (A / A)	
PUMY-SP140YK	R410A	15500	16500	3,30 / 4,10 (A / A)	

MOGUĆNOST SPAJANJA DO 8 UNUTARNJIH JEDINICA RAC SERIJE KORISTEĆI BRANCH BOX(OVE).



-20°C ~ 15°C
-5°C ~ 52°C



MODEL	MEDIJ	UČINAK (W)		EER / COP ENER. KLASA	NAPAJANJE (FAZA-NAPON-FREKVENCIJA)
		HLADENJE	GRIJANJE		
PUMY-P112VKM4	R410A	12500	14000	4,48 / 4,61 (A / A)	Monofazno 1Ph - 230V - 50Hz
PUMY-P125VKM4	R410A	14000	16000	4,05 / 4,28 (A / A)	
PUMY-P140VKM4	R410A	15500	18000	3,43 / 4,03 (A / A)	
PUMY-P112YKM4	R410A	12500	14000	4,48 / 4,61 (A / A)	Trofazno 3Ph - 400V - 50Hz
PUMY-P125YKM4	R410A	14000	16000	4,05 / 4,28 (A / A)	
PUMY-P140YKM4	R410A	15500	18000	3,43 / 4,03 (A / A)	
PUMY-P140YKM4	R410A	22400	25000	3,70 / 4,28 (A / A)	

MOGUĆNOST SPAJANJA DO 8 UNUTARNJIH JEDINICA RAC SERIJE KORISTEĆI BRANCH BOX(OVE).



-20°C ~ 15°C
-5°C ~ 52°C

**BRANCH BOX
(RAZDJELNIK)**

PAC-MK34BC	do 3 unutarnje jedinice
PAC-MK54BC	do 5 unutarnjih jedinica



BAKRENA RAČVA

MSDD-50BR-E	za spajanje branch Box-ova
MSDD-50AR-E	za spajanje branch Box-ova

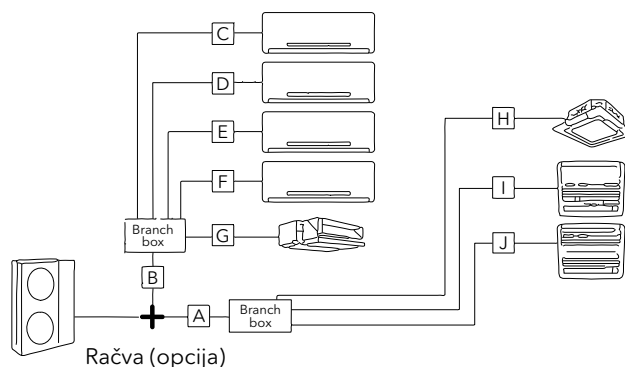
		PUMY SP MAX.	PUMY P MAX.
Ukupno cjevovoda	(A+B+C+D+E+F+G+H+I+J)	130m	150m
Vanjska jedinica - Branch box	(A+B)	55m	55m
Branch box - unutarnja jedinica	(C+D+E+F+G+H+I+J)	95m	95m
	pojedinačno (C,D,E,F,G,H,I,J)	25m	25m
Unutarnja jedinica - Vanjska jedinica	(najudaljenije)	80m	80m
Visinska razlika	Vanjska jedinica - Unutarnja jedinica*	50m	50m
	Branch box - Unutarnja jedinica	15m	15m
	Unutarnja jedinica - Unutarnja jedinica	12m	12m
Napomena	PUMY SP * U slučaju da je vanjska jedinica ispod razine unutarnjih jedinica: 40m PUMY P * U slučaju da je vanjska jedinica ispod razine unutarnjih jedinica: 30m		

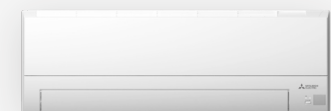

ODGOVARAJUĆE UNUTARNJE JEDINICE ZIDNA IZVEDBA



MSZ-BT 20/25/35 VG



MSZ-GF 60/71 VE



MSZ-AP

 MSZ-EF 25/35/42/50
WEB / VEV / VES

 MSZ-LN 25/35/50/60
VGW / VGB / VGR / VGV

MODEL	DIMENZIJE V / Š / D (mm)
MSZ-BT20VG	280 / 838 / 235
MSZ-BT25VG	280 / 838 / 235
MSZ-BT35VG	280 / 838 / 235
MSZ-GF60VE	325 / 1100 / 238
MSZ-GF71VE	325 / 1100 / 238
MSZ-AP15VF	250 / 760 / 178
MSZ-AP20VF	250 / 760 / 178
MSZ-AP25VG(K)	299 / 798 / 219
MSZ-AP35VG(K)	299 / 798 / 219
MSZ-AP42VG(K)	299 / 798 / 219
MSZ-AP50VG(K)	299 / 798 / 219
MSZ-AP60VG(K)	325 / 1100 / 257
MSZ-EF18VGKB	299 / 885 / 195
MSZ-EF22VGKB/W	299 / 885 / 195
MSZ-EF22VGKS	299 / 885 / 195
MSZ-EF25VGKB/W	299 / 885 / 195
MSZ-EF25VGKS	299 / 885 / 195
MSZ-EF35VGKB/W	299 / 885 / 195
MSZ-EF35VGKS	299 / 885 / 195
MSZ-EF42VGKB/W	299 / 885 / 195
MSZ-EF42VGKS	299 / 885 / 195
MSZ-EF50VGKB/W	299 / 885 / 195
MSZ-EF50VGKS	299 / 885 / 195
MSZ-LN25VGW*	307 / 890 / 233
MSZ-LN25VGB/R/V*	307 / 890 / 233
MSZ-LN35VGW*	307 / 890 / 233
MSZ-LN35VGB/R/V*	307 / 890 / 233
MSZ-LN50VGW*	307 / 890 / 233
MSZ-LN50VGB/R/V*	307 / 890 / 233

PODNA IZVEDBA



MODEL	DIMENZIJE V / Š / D (mm)
MFZ-KT25VG	600 / 750 / 215
MFZ-KT35VG	600 / 750 / 215
MFZ-KT50VG	600 / 750 / 215
MFZ-KT60VG	600 / 750 / 215

MODEL	DIMENZIJE V / Š / D (mm)
Uz uređaj je potrebno kupiti i PAR-40MAA ili PAC-YT52CRA-J.	
SEZ-M25DA	200 / 790 / 700
SEZ-M35DA	200 / 990 / 700
SEZ-M50DA	200 / 990 / 700
SEZ-M60DA	200 / 1190 / 700
SEZ-M71DA	200 / 1190 / 700

KANALSKA IZVEDBA

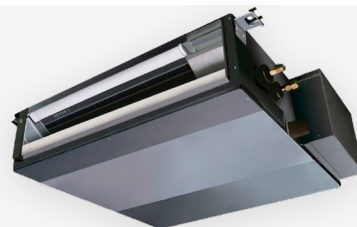

KAZETNA IZVEDBA 1-SMJERNA



MODEL	DIMENZIJE V / Š / D (mm)
MLZ-KP25VF	185 / 1102 / 360
MLP-444W	24 / 1200 / 424
MLZ-KP35VF	185 / 1102 / 360
MLP-444W	24 / 1200 / 424
MLZ-KP50VF	185 / 1102 / 360
MLP-444W	24 / 1200 / 424

4-SMJERNA



MODEL	DIMENZIJE V / Š / D (mm)
SLZ-M25FA	245 / 570 / 570
PAR-40MAA	120 / 120 / 19
SLP-2FAL	10 / 625 / 625
SLZ-M35FA	245 / 570 / 570
PAR-40MAA	120 / 120 / 19
SLP-2FAL	10 / 625 / 625
SLZ-M50FA	245 / 570 / 570
PAR-40MAA	120 / 120 / 19
SLP-2FAL	10 / 625 / 625
SLZ-M60FA	245 / 570 / 570
PAR-40MAA	120 / 120 / 19
SLP-2FAL	10 / 625 / 625
SLZ-M25FA	245 / 570 / 570
SLP-2FALM	10 / 625 / 625
SLZ-M35FA	245 / 570 / 570
SLP-2FALM	10 / 625 / 625
SLZ-M50FA	245 / 570 / 570
SLP-2FALM	10 / 625 / 625
SLZ-M60FA	245 / 570 / 570
SLP-2FALM	10 / 625 / 625



UPUTE I NAPOMENE

MSZ-BT 20/25/35 moguće spojiti samo na R32 multi sustave.
 MSZ/SEZ/MLZ/SLZ-35FA = nije moguće spojiti s MXZ-2F35VF
 MSZ/SEZ/MLZ/SLZ-50FA = nije moguće spojiti s MXZ-2F42VF
 SEZ-60DA = nije moguće spojiti s MXZ-2F42/53VF, MXZ-3F54VF
 MFZ-KJ podne jedinice nije moguće spojiti s MXZ R32
 MFZ-KT podne jedinice moguće je spojiti s MXZ R32
 SEZ-71DA moguće spojiti samo na MXZ-4E83VA i veće modele
 MXZ-DM = moguće je spojiti samo na MSZ-HJ modele unutarnjih jedinica
 MXZ-HA = moguće je spojiti samo na MSZ-HR modele unutarnjih jedinica
 MELCloud Wi-Fi sučelje nije moguće spojiti na MSZ-HJ, PCA-RP71/125HA, PEA-RP400/500GAQ

Osim navedenih modela unutarnjih jedinica, na multi DC inverter vanjske jedinice moguće je spojiti i slijedeće modele unutarnjih jedinica komercijalne serije:

KAZETNA: PLA-RP 50/60/71 EA, PODSTROPNA: PCA-M 50/60/71 KA,
 KANALNA: PEAD-M 50/60/71 JA(L)

Za detalje pogledati komercijalni katalog ili tehničke upute.

MODEL	OBJAŠNENJE	MASKA	DIMENZIJE V / Š / D (mm)
MAC-567IF-E  	Wi-Fi CONTROL INTERFACE: Kontrola unutarnjih jedinica preko aplikacije na smartphoneu, tabletu ili računalu (Potreban je po jedan interface na svaku unutarnju jedinicu).	SLP-2FALM	10 / 625 / 625
		SLP-2FAL	20 / 650 / 650
		MLP-444W	24 / 1200 / 424

UPRAVLJANJE ZA "RAC" I "S" SERIJU

DODATNA OPREMA - SAMO ZA INVERTERSKE MODELE

MODEL	OBJAŠNENJE
MAC-397IF-E	"A" CONTROL TERMINAL INTERFACE (Potreban je po jedan interface na svaku unutarnju jedinicu)
PAC-YT52CRA-K	Žičani daljinski upravljač
PAR-40MAA	Luksuzni žičani daljinski upravljač s Weekly Timer funkcijom

Osim navedenih upravljača, moguće je spojiti bilo koji upravljač iz VRF serije, a koji pripada "A" kontroli te se sustavno povezati s PAC ili VRF serijom.

MODEL	OBJAŠNENJE
MAC-334IF-E	"M-NET" INTERFACE (Potreban je po jedan interface na svaku unutarnju jedinicu)
PAR-U02MEDA	LUKSUZNI ŽIČANI DALJINSKI UPRAVLJAČ SA SENZOROM PRISUTNOSTI

Osim navedenih upravljača, moguće je spojiti bilo koji upravljač, kontrolu ili nadzor iz VRF serije, a koji pripadaju "M-NET" kontroli te se sustavno povezati s PAC ili VRF serijom.

MODEL	MXZ-2F33VF3 *3	MXZ-2F42VF3 *3	MXZ-2F53VF(H) *3	MXZ-2DM40VA *3	MXZ-2F53VFHZ *3	MXZ-3F54VF3 *3	MXZ-3F68VF3 *3	MXZ-3DM50VA *3	MXZ-3HA50VF *3	MXZ-4F72VF3 *3	MXZ-4E83VA *3	MXZ-4F80VF3 *3	MXZ-4F83VF *3	MXZ-5E102VA *3	MXZ-5F102VF *3	MXZ-6D122VA *3	MXZ-6F122VF *3	MXZ-2HA40VF *3	MXZ-2HA50VF *3	MXZ-3HA50VF *3
	A	2			3				4				5		6		2		3	
B	50	60	70	60	75	100	120	85	85	125	145	125	145	172	172	180	180	60	67	85
MSZ-LN18	•	•	•		•	•	•			•		•	•		•		•			
MSZ-LN25	•	•	•		•	•	•			•		•	•	•	•	•	•			
MSZ-LN35		•	•		•	•	•			•		•	•	•	•	•	•			
MSZ-LN50						•	•			•		•	•	•	•	•	•			
MSZ-FT25VG														•		•				
MSZ-FT35VG														•		•				
MSZ-FT50VG														•		•				
MSZ-AP15VG(K)	•	•	•		•	•	•			•		•	•	•	•	•	•			
MSZ-AP20VG(K)	•	•	•		•	•	•			•		•	•	•	•	•	•			
MSZ-AP25VG(K)	•	•	•		•	•	•			•		•	•	•	•	•	•			
MSZ-AP35VG(K)		•	•		•	•	•			•		•	•	•	•	•	•			
MSZ-AP42VG(K)			•		•	•	•			•		•	•	•	•	•	•			
MSZ-AP50VG(K)			•		•	•	•			•		•	•	•	•	•	•			
MSZ-AP60VG(K)							•			•		•	•	•	•	•	•			
MSZ-AP71VG(K)													•	•	•	•	•			
MSZ-EF18VG	•	•	•		•	•	•			•		•	•	•	•	•	•			
MSZ-EF22VG	•	•	•		•	•	•			•		•	•	•	•	•	•			
MSZ-EF25VG	•	•	•		•	•	•			•		•	•	•	•	•	•			
MSZ-EF35VG		•	•		•	•	•			•		•	•	•	•	•	•			
MSZ-EF42VG			•		•	•	•			•		•	•	•	•	•	•			
MSZ-EF50VG			•		•	•	•			•		•	•	•	•	•	•			
MSZ-BT20VG(K)	•	•	•		•	•	•			•		•	•		•		•			
MSZ-BT25VG(K)	•	•	•		•	•	•			•		•	•		•		•			
MSZ-BT35VG(K)		•	•		•	•	•			•		•	•		•		•			
MSZ-BT50VG(K)																				
MSZ-HR25VF										•								•	•	•
MSZ-HR35VF										•									•	•
MSZ-HR42VF										•										•
MSZ-HR50VF										•										
MSZ-HR60VF										•										
MSZ-HR71VF																				

*1 Maksimalan broj unutarnjih jedinica: 3A ili manje

*2 SEZ-M25 ne može biti povezan s MXZ-2F/3F/4F kada je ukupan kapacitet unutarnjih jedinica jednak kapacitetu vanjske jedinice (omjer kapaciteta jednak 1)

*3 MXZ vanjske jedinice nisu dizajnirane za rad s jednom unutarnjom jedinicom. Potrebna instalacija minimalno dvije unutarnje jedinice

MODEL	MXZ-2F33VF3 *3			MXZ-2F42VF3 *3			MXZ-2F53VF(H) *3			MXZ-2DM40VA *3			MXZ-2F53VFHZ *3			MXZ-3F54VF3 *3			MXZ-3F68VF3 *3			MXZ-3DM50VA *3			MXZ-3HA50VF *3			MXZ-4F72VF3 *3			MXZ-4E83VA *3			MXZ-4F80VF3 *3			MXZ-4F83VF *3			MXZ-5E102VA *3			MXZ-5F102VF *3			MXZ-6D122VA *3			MXZ-6F122VF *3			MXZ-2HA40VF *3			MXZ-2HA50VF *3			MXZ-3HA50VF *3		
	A	2						3						4						5			6			2			3																															
B	50	60	70	60	75	100	120	85	85	125	145	125	145	172	172	180	180	60	67	85																																								
MFZ-KT25VG	•	•	•		•	•	•			•		•	•	•	•	•	•																																											
MFZ-KT35VG		•	•		•	•	•			•		•	•	•	•	•	•																																											
MFZ-KT50VG						•	•			•		•	•	•	•	•	•																																											
MLZ-KP25VF	•	•	•		•	•	•		•	•		•	•	•	•	•	•																																											
MLZ-KP35VF		•	•		•	•	•		•	•		•	•	•	•	•	•																																											
MLZ-KP50VF						•	•		•	•		•	•	•	•	•	•																																											
SLZ-M15FA	•	•	•		•	•	•			•		•	•		•		•																																											
SLZ-M25FA	•	•	•		•	•	•			•		•	•	•	•	•	•																																											
SLZ-M35FA		•	•		•	•	•			•		•	•	•	•	•	•																																											
SLZ-M50FA						•	•			•		•	•	•	•	•	•																																											
SEZ-M25DA *2	•	•	•		•	•	•			•		•	•	•	•	•	•																																											
SEZ-M25DAL *2	•	•	•		•	•	•			•		•	•	•	•	•	•																																											
SEZ-M35DA		•	•		•	•	•			•		•	•	•	•	•	•																																											
SEZ-M35DAL		•	•		•	•	•			•		•	•	•	•	•	•																																											
SEZ-M50DA						•	•			•		•	•	•	•	•	•																																											
SEZ-M50DAL						•	•			•		•	•	•	•	•	•																																											
SEZ-M60DA							•			•		•	•	•	•	•	•																																											
SEZ-M60DAL							•			•		•	•	•	•	•	•																																											
SEZ-M71DA													•	•	•	•	•																																											
SEZ-M71DAL													•	•	•	•	•																																											
PCA-M50KA						•	•			•		•																																																
PCA-M60KA							•			•		•																																																
PCA-M71KA																																																												
PEAD-M50JA						•*1	•*1			•*1		•																																																
PEAD-M50JAL						•*1	•*1			•*1		•																																																
PEAD-M60JA																																																												
PEAD-M60JAL																																																												
PEAD-M71JA																																																												
PEAD-M71JAL																																																												

*1 Maksimalan broj unutarnjih jedinica: 3A ili manje

*2 SEZ-M25 ne može biti povezan s MXZ-2F/3F/4F kada je ukupan kapacitet unutarnjih jedinica jednak kapacitetu vanjske jedinice (omjer kapaciteta jednak 1)

*3 MXZ vanjske jedinice nisu dizajnirane za rad s jednom unutarnjom jedinicom.

Potrebna instalacija minimalno dvije unutarnje jedinice

MODEL	UČINAK hlađenje / grijanje (kW)	Promjer cijevi [tekućina/plin] (mm)	Razmak između nosača	Napajanje na jedinicu	Međuveza vanjske i unutarnje jedinice	Max. duljina / visinska razlika cijevi (m)	Prednapunjena duljina cijevi do	Nadopuna plina nakon udaljenosti prednapopune
MONO SPLIT (INVERTER) - R410A / *R32								
ZIDNA IZVEDBA								
MSZ-DW25VF*	2,5 / 3,15	6,35 / 9,52	500 mm	vanjsku 3 x 1,0 mm ²	4 x 1,0 mm ²	20 / 12	7,5 m	20 g/m
MSZ-DW35VF*	3,4 / 3,6	6,35 / 9,52	500 mm	vanjsku 3 x 1,0 mm ²	4 x 1,0 mm ²	20 / 12	7,5 m	20 g/m
MSZ-DW50VF*	5,0 / 5,4	6,35 / 9,52	500 mm	vanjsku 3 x 1,5 mm ²	4 x 1,0 mm ²	20 / 12	7,5 m	20 g/m
MSZ-RW25VG	2,5 / 3,2	6,35 / 9,52	500 mm	vanjsku 3 x 1,0 mm ²	4 x 1,0 mm ²	20 / 12	10 m	20 g/m
MSZ-RW35VG	3,5 / 4,0	6,35 / 9,52	500 mm	vanjsku 3 x 1,5 mm ²	4 x 1,0 mm ²	20 / 12	10 m	20 g/m
MSZ-RW50VG	5,0 / 6,0	6,35 / 9,52	500 mm	vanjsku 3 x 2,0 mm ²	4 x 1,0 mm ²	30 / 15	15 m	20 g/m
MSZ-LN25VG*	2,50 / 3,20	6,35 / 9,52	500 mm	vanjsku 3 x 1,0 mm ²	4 x 1,0 mm ²	20 / 12	10 m	20 g/m
MSZ-LN35VG*	3,50 / 4,00	6,35 / 9,52	500 mm	vanjsku 3 x 1,0 mm ²	4 x 1,0 mm ²	20 / 12	15 m	20 g/m
MSZ-LN50VG*	5,00 / 6,00	6,35 / 9,52	500 mm	vanjsku 3 x 2,0 mm ²	4 x 1,0 mm ²	20 / 12	15 m	20 g/m
MSZ-LN60VG*	6,10 / 6,80	6,35 / 12,7	500 mm	vanjsku 3 x 2,0 mm ²	4 x 1,0 mm ²	30 / 15	7 m	20 g/m
MSZ-FH25VE	2,50 / 3,20	6,35 / 9,52	500 mm	vanjsku 3 x 1,00 mm ²	4 x 1,0 mm ²	20 / 12	7 m	30 g/m
MSZ-FH35VE	3,50 / 4,00	6,35 / 9,52	500 mm	vanjsku 3 x 1,0 mm ²	4 x 1,0 mm ²	20 / 12	7 m	30 g/m
MSZ-FH50VE	5,00 / 6,00	6,35 / 12,7	500 mm	vanjsku 3 x 2,0 mm ²	4 x 1,0 mm ²	30 / 15	7 m	20 g/m
MSZ-EF25VE	2,50 / 3,20	6,35 / 9,52	500 mm	vanjsku 3 x 1,0 mm ²	4 x 1,0 mm ²	20 / 12	7 m	30 g/m
MSZ-EF35VE	3,50 / 4,00	6,35 / 9,52	500 mm	vanjsku 3 x 1,0 mm ²	4 x 1,0 mm ²	20 / 12	7 m	30 g/m
MSZ-EF42VE	4,20 / 5,40	6,35 / 9,52	500 mm	vanjsku 3 x 1,5 mm ²	4 x 1,0 mm ²	20 / 12	7 m	30 g/m
MSZ-EF50VE	5,00 / 5,80	6,35 / 12,7	500 mm	vanjsku 3 x 2,0 mm ²	4 x 1,0 mm ²	30 / 15	7 m	20 g/m
MSZ-BT20VG	2,0 / 2,5	6,35 / 9,52	500 mm	vanjsku 3 x 1,0 mm ²	4 x 1,0 mm ²	20 / 12	7 m	20 g/m
MSZ-BT25VG	2,5 / 3,15	6,35 / 9,52	500 mm	vanjsku 3 x 1,0 mm ²	4 x 1,0 mm ²	20 / 12	7 m	20 g/m
MSZ-BT35VG	3,5 / 3,6	6,35 / 9,52	500 mm	vanjsku 3 x 1,0 mm ²	4 x 1,0 mm ²	20 / 12	7 m	20 g/m
MSZ-BT50VG	5,0 / 5,4	6,35 / 12,7	500 mm	vanjsku 3 x 1,5 mm ²	4 x 1,0 mm ²	20 / 12	7 m	20 g/m
MSZ-GF60VE	6,10 / 6,80	6,35 / 15,88	500 mm	vanjsku 3 x 2,5 mm ²	4 x 1,0 mm ²	30 / 15	10 m	20 g/m
MSZ-GF71VE	7,10 / 8,10	9,52 / 15,88	500 mm	vanjsku 3 x 2,5 mm ²	4 x 1,0 mm ²	30 / 15	10 m	55 g/m
MSZ-AP20VG*	2,00 / 2,50	6,35 / 9,52	500 mm	vanjsku 3 x 1,0 mm ²	4 x 1,0 mm ²	20 / 12	7 m	20 g/m
MSZ-AP25VG*	2,50 / 3,20	6,35 / 9,52	500 mm	vanjsku 3 x 1,0 mm ²	4 x 1,0 mm ²	20 / 12	7 m	20 g/m
MSZ-AP35VG*	3,50 / 4,00	6,35 / 9,52	500 mm	vanjsku 3 x 1,0 mm ²	4 x 1,0 mm ²	20 / 12	7 m	20 g/m
MSZ-AP42VG*	4,20 / 5,40	6,35 / 9,52	500 mm	vanjsku 3 x 1,0 mm ²	4 x 1,0 mm ²	20 / 12	7 m	20 g/m
MSZ-AP50VG*	5,00 / 5,80	6,35 / 9,52	500 mm	vanjsku 3 x 2,0 mm ²	4 x 1,0 mm ²	20 / 12	7 m	20 g/m
MSZ-AP60VG*	6,10 / 6,80	6,35 / 12,7	500 mm	vanjsku 3 x 2,0 mm ²	4 x 1,0 mm ²	30 / 12	15 m	20 g/m
MSZ-AP71VG*	7,10 / 8,10	6,35 / 12,7	500 mm	vanjsku 3 x 2,5 mm ²	4 x 1,0 mm ²	30 / 12	15 m	20 g/m

MODEL	UČINAK hlađenje / grijanje (kW)	Promjer cijevi [tekućina/plin] (mm)	Razmak između nosača	Napajanje na jedinicu	Međuveza vanjske i unutarnje jedinice	Max. duljina / visinska razlika cijevi (m)	Prednapunjena duljina cijevi do	Nadopuna plina nakon udaljenosti prednapunje
MSZ-HR25VA*	2,50 / 3,10	6,35 / 9,52	500 mm	vanjsku 3 x 1,0 mm ²	4 x 1,0 mm ²	20 / 12	7 m	20 g/m
MSZ-HR35VA*	3,40 / 3,60	6,35 / 9,52	500 mm	vanjsku 3 x 1,0 mm ²	4 x 1,0 mm ²	20 / 12	7 m	20 g/m
MSZ-HR42VA*	4,20 / 4,70	6,35 / 9,52	500 mm	vanjsku 3 x 1,0 mm ²	4 x 1,0 mm ²	20 / 12	7 m	20 g/m
MSZ-HR50VA*	5,00 / 5,40	6,35 / 9,52	500 mm	vanjsku 3 x 1,5 mm ²	4 x 1,0 mm ²	20 / 12	7 m	20 g/m
MSZ-HR60VA*	6,10 / 6,80	6,35 / 12,7	500 mm	vanjsku 3 x 2,0 mm ²	4 x 1,0 mm ²	30 / 15	7 m	20 g/m
MSZ-HR71VA*	7,10 / 8,10	6,35 / 12,7	500 mm	vanjsku 3 x 2,0 mm ²	4 x 1,0 mm ²	30 / 15	7 m	20 g/m
MSZ-HJ25VA	2,50 / 3,15 kW	6,35 / 9,52	500 mm	unutarnju 3 x 1,0 mm ²	4 x 1,0 mm ²	20 / 12	7 m	20 g/m
MSZ-HJ35VA	3,15 / 3,60 kW	6,35 / 9,52	500 mm	unutarnju 3 x 1,0 mm ²	4 x 1,0 mm ²	20 / 12	7 m	20 g/m
MSZ-HJ50VA	5,00 / 5,40 kW	6,35 / 12,7	500 mm	unutarnju 3 x 1,5 mm ²	4 x 2,0 mm ²	20 / 12	7 m	20 g/m
MSZ-HJ60VA	6,10 / 6,80 kW	6,35 / 15,88	500 mm	unutarnju 3 x 2,0 mm ²	4 x 2,0 mm ²	30 / 15	7 m	20 g/m
MSZ-HJ71VA	7,10 / 8,10 kW	9,52 / 15,88	500 mm	unutarnju 3 x 2,0 mm ²	4 x 2,0 mm ²	30 / 15	7 m	20 g/m

MODEL	UČINAK hlađenje / grijanje (kW)	Promjer cijevi [tekućina/plin] (mm)	Razmak između nosača	Napajanje na jedinicu	Međuveza vanjske i unutarnje jedinice	Max. duljina / visinska razlika cijevi (m)	Pred- napunjena duljina cijevi do	Nadopuna plina nakon udaljenosti prednapunje
PODNA IZVEDBA								
MFZ-KT25VG*	2,50 / 3,40	6,35 / 9,52	500 mm	vanjsku 3 x 1,5 mm ²	4 x 1,5 mm ²	20 / 12	7 m	20 g/m
MFZ-KT35VG*	3,50 / 4,30	6,35 / 9,52	500 mm	vanjsku 3 x 1,5 mm ²	4 x 1,5 mm ²	20 / 12	7 m	20 g/m
MFZ-KT50VG*	5,00 / 6,00	6,35 / 12,7	500 mm	vanjsku 3 x 1,5 mm ²	4 x 1,5 mm ²	30 / 30	7 m	20 g/m
MFZ-KT60VG*	6,00 / 7,00	6,35 / 15,88	500 mm	vanjsku 3 x 1,5 mm ²	4 x 1,5 mm ²	30 / 30	7 m	20 g/m
KAZETNA IZVEDBA - 4-smjerna								
SLZ-M25FA	2,60 / 3,20	6,35 / 9,52	500 mm	vanjsku 3 x 1,5 mm ²	4 x 1,5 mm ²	20 / 12	7 m	30 g/m
SLZ-M35FA	3,50 / 4,00	6,35 / 9,52	500 mm	vanjsku 3 x 1,5 mm ²	4 x 1,5 mm ²	20 / 12	7 m	30 g/m
SLZ-M50FA	4,60 / 5,00	6,35 / 12,7	500 mm	vanjsku 3 x 2,5 mm ²	4 x 1,5 mm ²	30 / 30	7 m	20 g/m
SLZ-M60FA	5,60 / 6,40	6,35 / 15,88	500 mm	vanjsku 3 x 2,5 mm ²	4 x 1,5 mm ²	30 / 30	7 m	20 g/m
KAZETNA IZVEDBA - 1-smjerna								
MLZ-KP25VF	2,50 / 3,20	6,35 / 9,52	500 mm	vanjsku 3 x 1,5 mm ²	4 x 1,5 mm ²	20 / 12	7 m	30 g/m
MLZ-KP35VF	3,50 / 4,10	6,35 / 9,52	500 mm	vanjsku 3 x 1,5 mm ²	4 x 1,5 mm ²	20 / 12	7 m	30 g/m
MLZ-KP50VF	5,00 / 6,00	6,35 / 12,7	500 mm	vanjsku 3 x 2,5 mm ²	4 x 1,5 mm ²	30 / 30	7 m	20 g/m

MODEL	UČINAK hlađenje / grijanje (kW)	Promjer cijevi [tekućina/plin] (mm)	Razmak između nosača	Napajanje na jedinicu	Međuveza vanjske i unutarnje jedinice	Max. duljina / visinska razlika cijevi (m)	Pred- napunjena duljina cijevi do	Nadopuna plina nakon udaljenosti prednapunje
KANALSKA IZVEDBA								
SEZ-M25DA	2,50 / 2,90	6,35 / 9,52	500 mm	vanjsku 3 x 1,5 mm ²	4 x 1,5 mm ²	20 / 12	7 m	30 g/m
SEZ-M35DA	3,50 / 4,20	6,35 / 9,52	500 mm	vanjsku 3 x 1,5 mm ²	4 x 1,5 mm ²	20 / 12	7 m	30 g/m
SEZ-M50DA	5,00 / 6,00	6,35 / 12,7	500 mm	vanjsku 3 x 2,5 mm ²	4 x 1,5 mm ²	30 / 30	7 m	20 g/m
SEZ-M60DA	6,10 / 7,40	6,35 / 15,88	500 mm	vanjsku 3 x 2,5 mm ²	4 x 1,5 mm ²	30 / 30	7 m	20 g/m
SEZ-M71DA	7,10 / 8,00	9,52 / 15,88	500 mm	vanjsku 3 x 2,5 mm ²	4 x 1,5 mm ²	30 / 30	7 m	55 g/m
MULTI SPLIT VANJSKE JEDINICE - *Napomena: Maksimalna visinska razlika ukoliko je vanjska jedinica montirana iznad unutarnje								
MXZ-2F33VF	3,30 / 4,00	2x (6,35 / 9,52)	500 mm	vanjsku 3 x 2,5 mm ²	2x (4 x 1,5 mm ²)	20 / 10 (pojedinačno unutarnja max. 15m)	20 m	0
MXZ-2F42VF	4,20 / 4,50	2x (6,35 / 9,52)	500 mm	vanjsku 3 x 2,5 mm ²	2x (4 x 1,5 mm ²)	30 / 15 (10*) (pojedinačno unutarnja max. 20m)	30 m	0
MXZ-2F53VF	5,30 / 6,40	2x (6,35 / 9,52)	500 mm	vanjsku 3 x 2,5 mm ²	2x (4 x 1,5 mm ²)	30 / 15 (10*) (pojedinačno unutarnja max. 20m)	30 m	0
MXZ-3F54VF	5,40 / 7,00	3x (6,35 / 9,52)	500 mm	vanjsku 3 x 2,5 mm ²	3x (4 x 1,5 mm ²)	50 / 15 (10*) (pojedinačno unutarnja max. 25m)	50 m	0
MXZ-3F68VF	6,80 / 8,60	3x (6,35 / 9,52)	500 mm	vanjsku 3 x 2,5 mm ²	3x (4 x 1,5 mm ²)	60 / 15 (10*) (pojedinačno unutarnja max. 25m)	60 m	0
MXZ-4F72VF	7,20 / 8,60	4x 6,35 / 3x 9,52 + 1x 12,7	500 mm	vanjsku 3 x 2,5 mm ²	4x (4 x 1,5 mm ²)	60 / 15 (10*) (pojedinačno unutarnja max. 25m)	60 m	0
MXZ-4F83VF	8,30 / 9,00	4x 6,35 / 3x 9,52 + 1x 12,7	600 mm	vanjsku 3 x 2,5 mm ²	4x (4 x 1,5 mm ²)	70 / 15 (10*) (pojedinačno unutarnja max. 25m)	70 m	0
MXZ-5F102VF	10,20 / 10,50	5x 6,35 / 4x 9,52 + 1x 12,7	600 mm	vanjsku 3 x 2,5 mm ²	5x (4 x 1,5 mm ²)	80 / 15 (10*) (pojedinačno unutarnja max. 25m)	80 m	0
MXZ-6F122VF	12,20 / 14,00	6x 6,35 / 5x 9,52 + 1x 12,7	600 mm	vanjsku 3 x 4,0 mm ²	6x (4 x 1,5 mm ²)	80 / 15 (10*) (pojedinačno unutarnja max. 25m)	80 m	0
MXZ-2DM40VA	4,00 / 4,30	2x (6,35 / 9,52)	500 mm	vanjsku 3 x 2,5 mm ²	2x (4 x 1,5 mm ²)	30 / 15 (10*) (pojedinačno unutarnja max. 20m)	20 m	20 g/m
MXZ-3DM50VA	5,00 / 6,00	3x (6,35 / 9,52)	500 mm	vanjsku 3 x 2,5 mm ²	3x (4 x 1,5 mm ²)	50 / 15 (10*) (pojedinačno unutarnja max. 25m)	40 m	20 g/m
MXZ-2HA40VF	4,00 / 4,30	2x (6,35 / 9,52)	500 mm	vanjsku 3 x 2,0 mm ²	2x (4 x 1,5 mm ²)	30 / 15 (pojedinačno unutarnja max. 20m)	30 m	0
MXZ-2HA50VF	5,00 / 6,00	2x (6,35 / 9,52)	500 mm	vanjsku 3 x 2,0 mm ²	2x (4 x 1,5 mm ²)	30 / 15 (10) (pojedinačno unutarnja max. 20m)	30 m	0
MXZ-3HA50VF	5,00 / 6,00	3x (6,35 / 9,52)	500 mm	vanjsku 3 x 2,5 mm ²	3x (4 x 1,5 mm ²)	50 / 15 (10) (pojedinačno unutarnja max. 25m)	40 m	20 g/m

* Za VF2/VF3 ne treba nadopuna plina.

MODEL	UČINAK hlađenje / grijanje (kW)	Promjer cijevi [tekućina/plin] (mm)	Razmak između nosača	Napajanje na jedinicu	Međuveza vanjske i unutarnje jedinice	Max. duljina / visinska razlika cijevi (m)	Prednapunjena duljina cijevi do	Nadopuna plina nakon udaljenosti prednadopune
PUMY-SP112VK	12,50 / 14,00	9,52 / 15,88	600 mm	vanjsku 3 x 6,0 mm ²	Navedeni podaci za slučaj spajanja Branch Box i RAC/ PAC unutarnjih jedinica: vanjska → B. Box 1-2 x (3 x 1,5 mm ² + oklopljeni Liycy 2 x 1,25 mm ²) B. Box → unutarnje 2-8 x (4 x 1,5 mm ²)	Navedeni podaci za slučaj spajanja Branch Box(ova) i RAC/PAC unutarnjih jedinica: 120 / 30 (50*)m pojedinačno unutarnja max.: 80m od vanjske do B.Box max. 55m max. od B.Box do unutarnjih: 95m pojedinačno od B.Box do unutarnje: 25m max.visina između unutarnjih: 12m max.visinska razl. B.Box i unutarnje: 15m	0 m	Kontaktirati Deltron
PUMY-SP125VK	14,00 / 16,00	9,52 / 15,88	600 mm	vanjsku 3 x 6,0 mm ²			0 m	
PUMY-SP140VK	15,50 / 16,50	9,52 / 15,88	600 mm	vanjsku 3 x 6,0 mm ²			0 m	
PUMY-SP112YK	12,50 / 14,00	9,52 / 15,88	600 mm	vanjsku 5 x 2,5 mm ²			0 m	
PUMY-SP125YK	14,00 / 16,00	9,52 / 15,88	600 mm	vanjsku 5 x 2,5 mm ²			0 m	
PUMY-SP140YK	15,50 / 16,50	9,52 / 15,88	600 mm	vanjsku 5 x 2,5 mm ²			0 m	

MODEL	UČINAK hlađenje / grijanje (kW)	Promjer cijevi [tekućina/plin] (mm)	Razmak između nosača	Napajanje na jedinicu	Međuveza vanjske i unutarnje jedinice	Max. duljina / visinska razlika cijevi (m)	Prednapunjena duljina cijevi do	Nadopuna plina nakon udaljenosti prednadopune
PUMY-P112VK	12,50 / 14,00	9,52 / 15,88	600 mm	vanjsku 3 x 6,0 mm ²	Navedeni podaci za slučaj spajanja Branch Box i RAC/ PAC unutarnjih jedinica: vanjska → B. Box 1-2 x (3 x 1,5 mm ² + oklopljeni Liycy 2 x 1,25 mm ²) B. Box → unutarnje 2-8 x (4 x 1,5 mm ²)	Navedeni podaci za slučaj spajanja Branch Box(ova) i RAC/PAC unutarnjih jedinica: 150 / 40 (50*)m pojedinačno unutarnja max.: 80m od vanjske do B.Box max. 55m max. od B.Box do unutarnjih: 95m pojedinačno od B.Box do unutarnje: 25m max.visina između unutarnjih: 12m max.visinska razl. B.Box i unutarnje: 15m	0 m	Kontaktirati Deltron
PUMY-P125VK	14,00 / 16,00	9,52 / 15,88	600 mm	vanjsku 3 x 6,0 mm ²			0 m	
PUMY-P140VK	15,50 / 18,00	9,52 / 15,88	600 mm	vanjsku 3 x 6,0 mm ²			0 m	
PUMY-P112YK	12,50 / 14,00	9,52 / 15,88	600 mm	vanjsku 5 x 2,5 mm ²			0 m	
PUMY-P125YK	14,00 / 16,00	9,52 / 15,88	600 mm	vanjsku 5 x 2,5 mm ²			0 m	
PUMY-P140YK	15,50 / 18,00	9,52 / 15,88	600 mm	vanjsku 5 x 2,5 mm ²			0 m	
PUMY-P200YKM1	22,40 / 25,00	9,52 / 19,1	600 mm	vanjsku 5 x 2,5 mm ²	Navedeni podaci za slučaj spajanja Branch Box(ova) i RAC/PAC unutarnjih jedinica: vanjska → B.Box 1-2 x (3x1,5mm ² + oklopljeni Liycy 2x1,25mm ²) B.Box → unutarnje 2-8 x (4x1,5mm ²)	Navedeni podaci za slučaj spajanja Branch Box(ova) i RAC/PAC unutarnjih jedinica: 150 / 40 (50*)m pojedinačno unutarnja max.: 80m od vanjske do B.Box max. 55m max. od B.Box do unutarnjih: 95m pojedinačno od B.Box do unutarnje: 25m max.visina između unutarnjih: 12m max.visinska razl. B.Box i unutarnje: 15m	0 m	Kontaktirati Deltron

(KÓD) UNUTARNJE JEDINICE

15	1,50 / 1,70	6,35 / 9,52
18	1,80 / 3,30	6,35 / 9,52
20	2,00 / 2,20	6,35 / 9,52
22	2,20 / 3,30	6,35 / 9,52
25	2,50 / 3,20	6,35 / 9,52

***R32 MODELI**

35	3,50 / 4,00	6,35 / 9,52
42	4,20 / 5,40	6,35 / 9,52
50	5,00 / 5,80	6,35 / 12,7 *6,35/9,52
60	6,10 / 6,80	6,35 / 15,88
71	7,10 / 8,10	9,52 / 15,88

Način punjenja rashladnim sredstvom

Ukupna količina rashladnog sredstva *3	=	Pretpunjenje	+	Broj unutarnje jedinice *1	+	Priključak pojedine UJ *2	+	Dužina cijevi
_____ kg		1,4 kg		_____ kg		_____ kg		0,0 kg

*1 Ako priključite 3 ili 4 unutarnje jedinice, dodajte **0,5 kg** rashladnog sredstva.

*2 Ako priključite sljedeću/e jedinicu/e, dodajte **0,17 kg po jednoj jedinici**.

MSZ-LN18/25/35VG MLZ-KP25/35/50VF
SEZ-M50DA(L) PCA-M50/60KA
PEAD-M50JA(L)

*3 Ako ukupna količina rashladnog sredstva za sve uređaje bude veća od **2,4 kg**, dopunite samo **1,0 kg** kako se ne bi prekoračila ukupna maksimalna količina.

TABLICA ZA NADOPUNU FREONA MULTI SPLIT R32 UREĐAJA

NAPOMENE:

Molimo da prije narudžbe provjerite isporučivost pojedinog uređaja.

GARANCIJA NA UREĐAJE:

36 mjeseci, uz pridržavanje uputa za rukovanje.



DELTRON[®]

Generalni zastupnik
Mitsubishi Electric klima uređaja

Split, Vukovarska 148
Tel: +385 (0)21 453 400
Fax: +385 (0)21 473 943
deltron@deltron.hr

Zagreb, Zagrebačka avenija 104
Tel: +385 (0)1 60 64 777
Fax: +385 (0)1 60 64 778
deltron.zagreb@deltron.hr

Sarajevo, Pijačna 14K
Tel: +387 (0)33 840 200
Fax: +387 (0)33 840 203
deltron.sarajevo@deltron.ba

DISTRIBUTER

